

Article number: 2310431146S

Description: E+G Levelling elements
LX.40-SW17-SST-M10X72-S

Measures

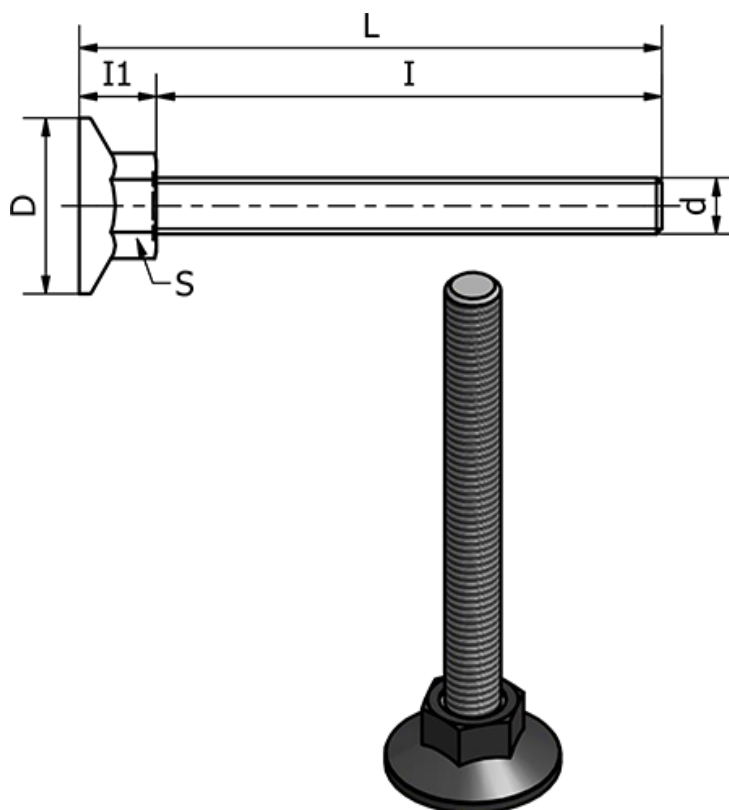

d = M10

D = 40

I = 72

I1 = 13

L = 84.5

S = 17

Static load in (N) = 3000

Type = AISI 304 Rustfast

Weight (g) = -